

MULTIEWER (MVR) MENU

M1: Select MVR Sources - From the dropdown menus select the Inputs, Backgrounds, and Destinations you want to view and drop them into Multiviewer Outputs. Overlapping is not allowed. An MVR source may be used twice. A maximum total of 63 windows can be used for Inputs and 63 windows can be used for Outputs.

M2: Adjust Window - Adjust the size, position and the color parameters associated with each window. Repeat for all Inputs and save.

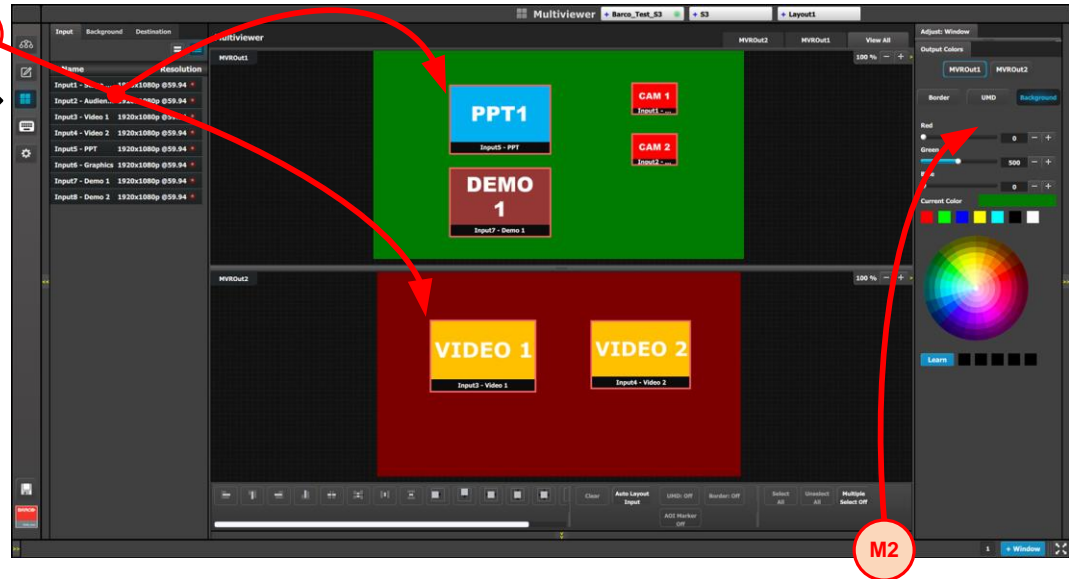

SETTINGS MENU

S1: Options - On the Options tab click on the boxes to select system wide user preferences such as Layer positioning.

S2: Tools - Allows users to perform Backup and Restore operations or download the latest software from the Barco website

S3: Dashboard - Provides status information regarding the cards and other system diagnostic information.

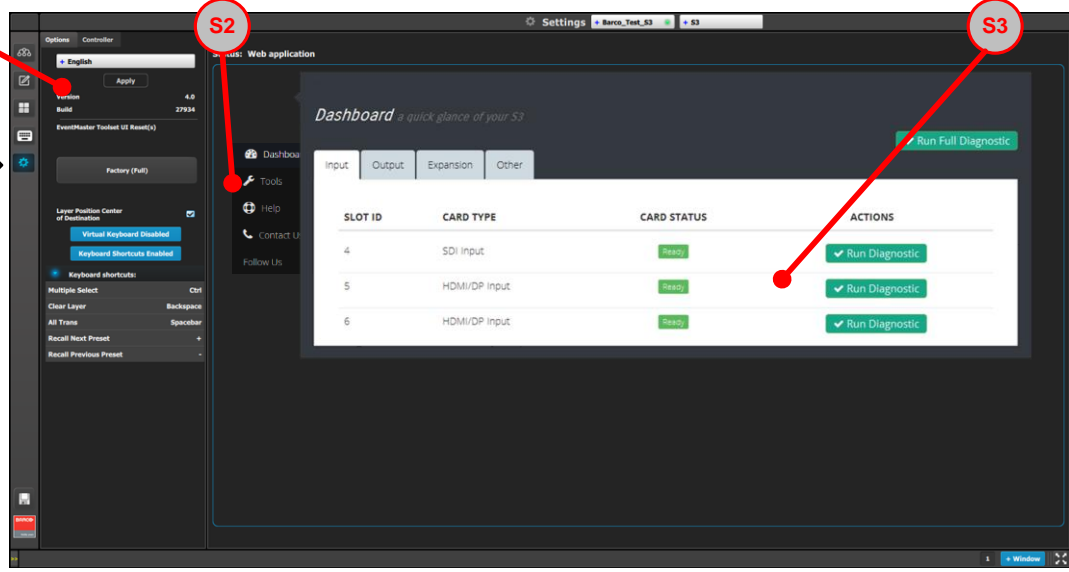

Linking

An Event Master unit can link with other Event Master units. Depending on the linking configuration, linked units share inputs, and they expand the number of layers and outputs. For more information on linking, see Section 6.17 "Configuration Menu > Linking in the Event Master Devices User's Guide, or see the instructional videos on the Barco Folsom IP YouTube site.

For links to other quick-start guides and the Event Master Devices User's Guide, see the Technical Downloads tab for each product on the Barco Presentation switchers page at: <https://www.barco.com/en/Products/Image-processing/Presentation-switchers>

For links to instructional videos, see the Barco Folsom IP YouTube site at: <https://www.youtube.com/user/BarcoFolsomIP>.

Link Connections

1. Check the cable orientation for keying. The cable fits in only one orientation.
2. Fully insert the cable into the connector on the Link Card.
3. If the cable resists full insertion, do not force it; pull the cable out, check its orientation, and reinsert it.
4. Make sure that the latch is properly engaged.
5. Always use the release when removing the cable.

Improper insertion or removal of Link cables can damage the connectors and is not covered under the product warranty.

Example: Linking an S3-4K to a pair of EX units

Each S3-4K is equipped with a single Link card in slot 1. The Link card is identified by a yellow stripe at the top.

Be sure that you properly align the Link cable connectors prior to insertion. Connectors should insert easily with almost no resistance, until the lock is about to engage. Be sure that the lock engages fully to ensure proper contact. Make sure that you use the locking mechanism and then push each cable until it locks in place.

1. Connect the Link cables provided with each unit between the Link connectors as follows:
 - S3-4K VP ID 0, Link 1 >> EX VP ID 1, Link 2
 - EX VP ID 1, Link 1 >> EX VP ID 2, Link 2

2. Make sure that the S3-4K and the EX units have different IP addresses. The default IP address for each unit is the same; two of them must be changed.
3. Connect all devices to network Ethernet.
4. Start the Event Master Toolset version 4.0 or higher.
5. Make sure that the S3-4K and the EX units are discovered on the network and that they have different Unit IDs. If the system does not discover your device, you may manually add it. See "How to manually add a device into the selected system" in the user's guide.
6. Drop the S3-4K in the EM GUI. If the S3-4k unit is cabled to an EX unit or a pair of daisy-chained EX units, the EX unit appears as a grayed-out box below the S3-4K unit in the Diagram area. In the grayed-out EX box, a blue button allows you to add the EX to the system as a slave.
7. Click the blue add button to add the EX unit. If you are adding two daisy-chained EX units, you must add the first EX in the chain before the second EX in the chain is displayed, then repeat Step 7 to add the second EX in the chain.
8. (Optional) Name each unit so that you can identify it in your setup.

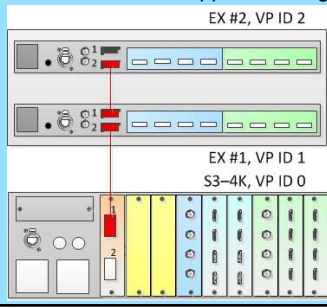

BARCO Event Master S3-4K - Screen Management System Quick Start Guide

Barco Technical Support:
USA: +1 (866) 374-7878
EMEA: 0800 90 0410
CHINA: 40088 22726
APAC: +603-78803362
www.barco.com/en/Support

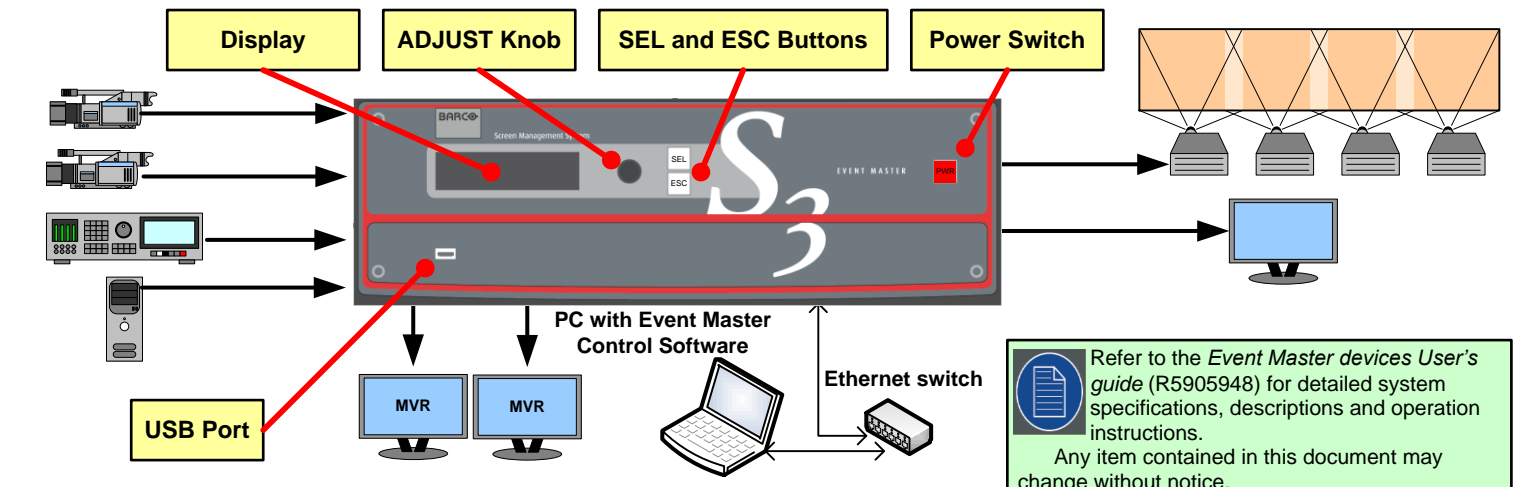

Refer to the Event Master devices User's guide (R5905948) for detailed system specifications, descriptions and operation instructions. Any item contained in this document may change without notice. For the latest version of the Event Master devices User's guide (R5905948) and the S3-4K - Screen Management System Quick Start Guide (26-1205004-00), visit www.barco.com.

System Setup

1. Ensure that the unit is physically secured in a rack or is placed on a flat surface with stable support. If the unit is installed in a rack, **it is mandatory that the rear brackets are also installed.**
 2. Connect all sources, displays, and peripherals to the S3-4K according to your event's requirements.
 3. Connect AC power to the unit. If power redundancy is desired, connect power to both power plugs.
 4. Connect to a computer that has the Event Master control software installed, via an Ethernet cable. A switch is optional if additional devices will be connected.
 5. Power up the S3-4K, the PC, and all monitors and peripherals.
 6. Verify that no error messages appear on the S3-4K front panel.
 7. After the S3-4K boots up, run the Event Master control software and follow the sequence of instructions listed in this Quick Start Guide to complete the system setup and configuration.
- Should the system not fully boot correctly, press and hold the SEL and ESC buttons while applying power to the unit. Release these buttons when a menu appears asking to Factory Reset the unit. Perform the Factory Reset and the unit will boot normally.

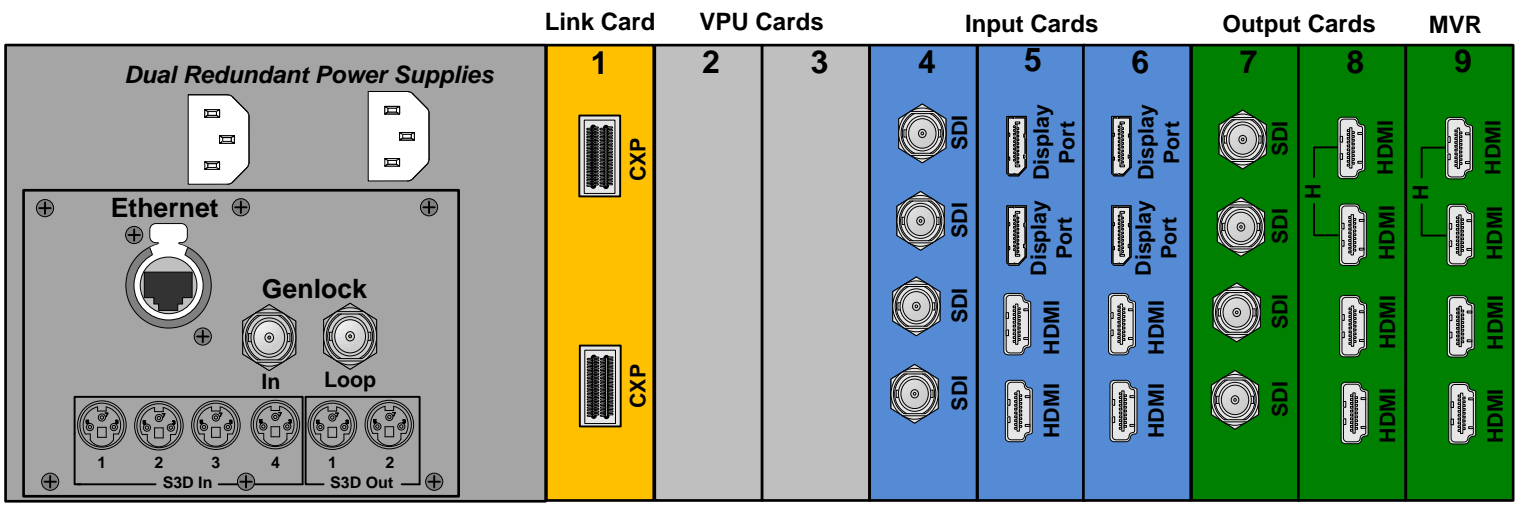

Expansion Card
- 2 High speed CXP connectors

SDI Input & Output Cards
- 4 SDI BNC connectors
- SD/HD/3G formats (6G ready)

DisplayPort/HDMI Combo Input Cards
- 2 DP and 2 HDMI locking connectors
- Displayport 1.1a specification
- HDMI 1.4a specification
- HDCP 1.4 & EDID 1.3

DVI Input Cards
- 2 DVI-I connectors (no analog signals)
- Single / Dual Link formats
- DVI 1.0 specification
- HDCP 1.4 & EDID 1.3

Quad Channel DisplayPort Output Cards
- 4 full-size DP locking connectors
- Up to 4 independent signals
- DisplayPort 1.2 specification
- HDCP will be supported in a future software release.

HDMI Output cards (including MVR)
- 4 HDMI connectors (top 2 connectors capable of high-speed HDMI signals up to 300 MHz)
- HDMI 1.4a specification
- HDCP 1.4 and EDID 1.3

Notes:
- Input and Output cards each support one 4K/UHD signal.
- This sample system shows the optional DP 1.2 Output card. The system does not ship with this card; your configuration may be different.
- Cards are **not** hot-swappable.

Event Master Control Software Flowchart

CONFIGURATION MENU

- C1: Discovery** - When the Event Master control software loads, it automatically discovers the devices connected to the network. These devices are listed on the left hand side of the configuration screen.
- C2: Connect** - Click on the device you want to connect and drag it in the middle area. The software should automatically establish communication with the unit. If connection between the PC and the S3-4K is not achieved, re-check the wire connection. On the Configuration Menu, ensure that the IP settings match with the S3-4K settings that are available from the front panel. You can also connect to the S3-4K by typing the IP address manually.
- C3: System Parameters** - Select the desired Native Rate, Genlock Mode, and Preset Conflict Mode.
- C4: Add Backgrounds** - Select and define input connectors as a background. Select the Adjust tab and perform any additional adjustments. Repeat for all Backgrounds and save. Max. of 4 connectors of the same type can be assigned per background (Except for DVI & HDMI).
- C5: Add Inputs** - Select and define input connectors as Inputs. Select the Adjust tab and perform any additional adjustments. Repeat for all Inputs and save. Max. of 4 connectors of the same type can be assigned per input.
- C6: Add Outputs** - Select and define output connectors as Outputs. Select the Adjust tab and perform any necessary adjustments. Repeat for all Outputs and save. Max. of 4 connectors of the same type can be assigned per output.
- Output Test Patterns (Optional)** - Under the Adjust and Output tabs select the test patterns on one or more outputs, to assist with external device setup
- C7: Add Multiviewer Outputs** - Select connectors from the MVR slot and define them as a MVR Output. Repeat for all Outputs and save.
- C8: Add Screen Destinations** - Select the corresponding output connector(s) from the same card and add them to Screen Destinations via drag and drop. From the Adjust tab, add the number of desired layers and perform any necessary adjustments. Repeat for all Screen Destinations and save.
- C9: Add Aux Destinations** - Select the corresponding output connector(s) from the same card and add them to Aux Destinations. Select the Adjust tab and perform any necessary adjustments. Repeat add all Aux Screen Destinations and save.

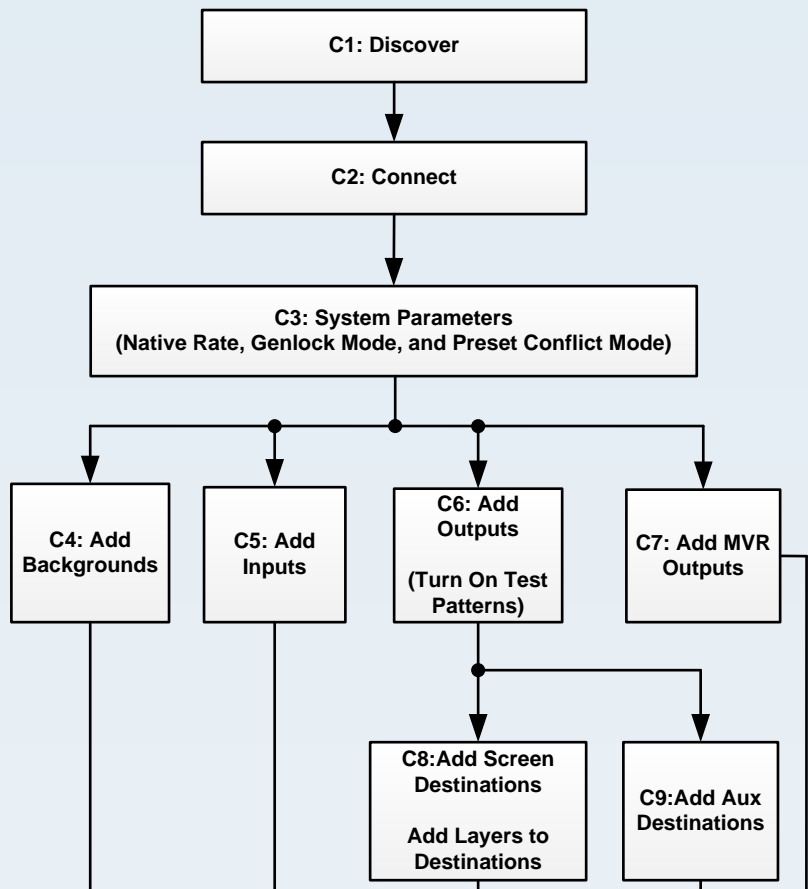

PROGRAMMING MENU

- P1: Select thumbnails for Backgrounds** - Press **Refresh All**, or select the thumbnails to represent the Backgrounds.
- P2: Select thumbnails for Inputs & Stills** - Press **Refresh All**, or select the thumbnails to represent Inputs and Stills
- P3: Create Source Files** - Under the Input tab create any additional source files (optional). Select the Adjust tab and perform any additional adjustments and press **Save**. Repeat for all Inputs/Sources and save.
- P4: Drop Backgrounds into Screen Destinations** - Under the Background tab select a Background and drop it to a Screen Destinations. Repeat for all Backgrounds and save.
- P5: Drop Layers & Sources** - Under the Layer tab select a layer and drop it to a Screen Destination. Select a Source under the Input tab and drop it into the layer. Alternatively, select a source and drag it to the destination to automatically show the layer with the selected source. Select the Adjust tab and perform any additional adjustments. Repeat for all layers and sources and save.
- P6: Drop Inputs \ Backgrounds to Aux Destinations** - Under the Input or Background tabs select a Input \ Background and drop it to the Aux Destinations. Select the Adjust tab and perform any additional adjustments. Repeat for all Backgrounds and save.
- P7: User Keys** - Select a layer and under Adjust and User Keys tabs click on the Enables to save. Repeat for all desired User Keys and save.
- P8: Presets** - Select Screen(s) and under Adjust and Preset tabs create a new preset or manage existing ones. Repeat to create multiple Presets.

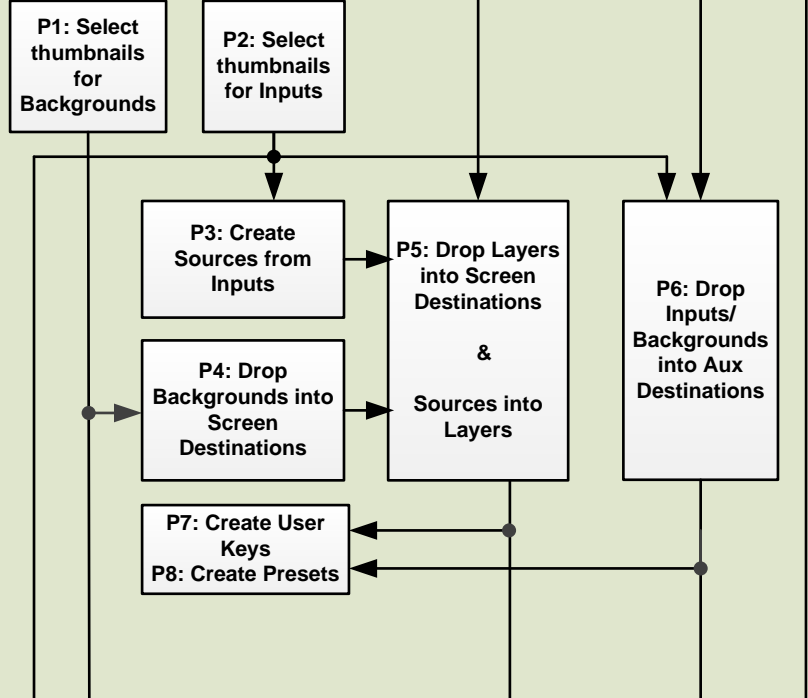

Refer to the User's Guide for a detailed description of each step

Multiviewer Menu (next page)

System Initialization

- Return to Factory Default (Optional)** - For a new event, back up your system if desired, then perform a complete factory reset. For a continuing (or multi-day) event, this step is not required.
- Restoring the System (Optional)** - Insert a USB drive with a previous backup file into the USB Port. On the Backup and Restore Menu, press {Restore System} and follow the prompts.
- Backing up the System (Optional)** - Insert a USB drive into the USB Port. On the Backup and Restore Menu, press {Backup System} to back up the system setup and all memory registers.
- Factory Reset, System Backup and Restore** - Operations can be performed from the Events Master Control software or from the front panel.

